

PROJECT	
TYPE	
SPECIFIER	
QUANTITY	
DATE	

## SPILLO 1 ROD SURFACE

**D42036-** -

base number                          
 Color            Temperature    Finish            Options

- To build a product code in our configurator select the specify button on the base model # product page
- To build a manual product code on this datasheet choose from the options listed below in blue font and add the suffix to the base model #

### GENERAL

Series: Spillo  
 Subseries: Spillo 1 Rod  
 Brand: Icone  
 Division: Design  
 Mounting Type: Surface  
 Mounting Location: Wall  
 Subcategory: Ambient

### PHYSICAL

Shape: Rectangle  
 Width (mm): 32  
 Width (in): 1 ¼  
 Height (mm): 700  
 Height (in): 27 9/16  
 Extension (mm): 660  
 Extension (in): 26  
 Light Distribution: Direct / Indirect  
 Fixture Finish: WHI / WHC / BLK / BGD  
 Fixture Material: Brass

### ELECTRICAL

Lamp Type: LED  
 Total Output Wattage (W): 7.92  
 Dimming: 0-10V Dimming  
 Driver Included: Yes  
 Driver Location: Integrated  
 Driver Type: Constant Voltage - 120Vac - non-dimming  
 Driver Class: Class 2  
 Input Voltage (V): 120 - 277  
 Output Voltage (V): 12  
 Upon Request: (Not included - see components) Remote: 0-10Vdc dimming / 277Vac

### LED

Color Temperature (°K): 2700 / 3000  
 Nominal Lumen (lm): 660  
 CRI: >90 CRI  
 Lamp Life (hrs): 50000

### OPTICAL

Adjustability: Tilt 90°

### RATINGS AND CERTIFICATIONS

Certified By: Certified for North American Standards  
 IP rating: IP20

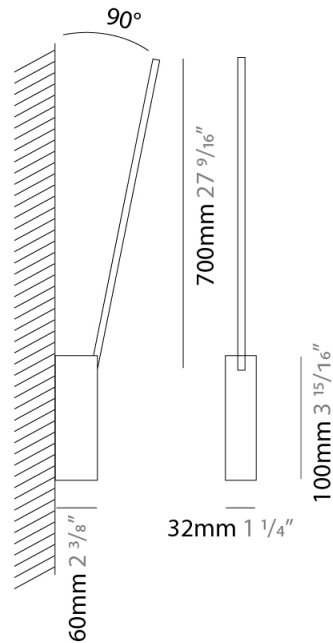
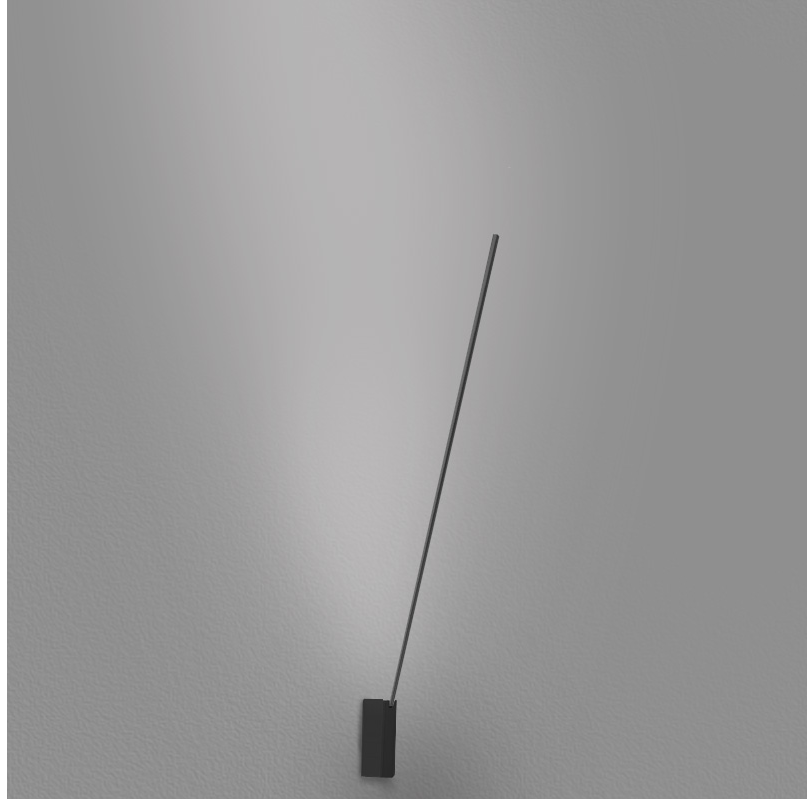

## SPILLO 1 ROD SURFACE

D42036-

PROJECT

TYPE

SPECIFIER

QUANTITY

DATE



D

## SPILLO 1 ROD SURFACE

**D42037-** -

base number                              
 Color            Temperature    Finish            Options

- To build a product code in our configurator select the specify button on the base model # product page
- To build a manual product code on this datasheet choose from the options listed below in blue font and add the suffix to the base model #

**GENERAL**

Series: Spillo  
 Subseries: Spillo 1 Rod  
 Brand: Icone  
 Division: Design  
 Mounting Type: Surface  
 Mounting Location: Wall  
 Subcategory: Ambient

**PHYSICAL**

Shape: Rectangle  
 Width (mm): 32  
 Width (in): 1 1/4  
 Height (mm): 970  
 Height (in): 38 3/16  
 Extension (mm): 860  
 Extension (in): 33 7/8  
 Light Distribution: Direct / Indirect  
 Fixture Finish: WHI / WHC / BLK / BGD  
 Fixture Material: Brass

**ELECTRICAL**

Lamp Type: LED  
 Total Output Wattage (W): 10.56  
 Dimming: Non-Dimmable  
 Driver Included: Yes  
 Driver Location: Integrated  
 Driver Type: Constant Voltage - 120Vac - non-dimming  
 Driver Class: Class 2  
 Input Voltage (V): 120 - 277  
 Output Voltage (V): 12  
 Upon Request: (Not included - see components) Remote: 0-10Vdc dimming / Non-dimming 120/277Vac

**LED**

Color Temperature (°K): 2700 / 3000  
 Nominal Lumen (lm): 880  
 CRI: >90 CRI  
 Lamp Life (hrs): 50000

**OPTICAL**

Adjustability: Tilt 90°

**RATINGS AND CERTIFICATIONS**

Certified By: Certified for North American Standards  
 IP rating: IP20

PROJECT
TYPE
SPECIFIER
QUANTITY
DATE

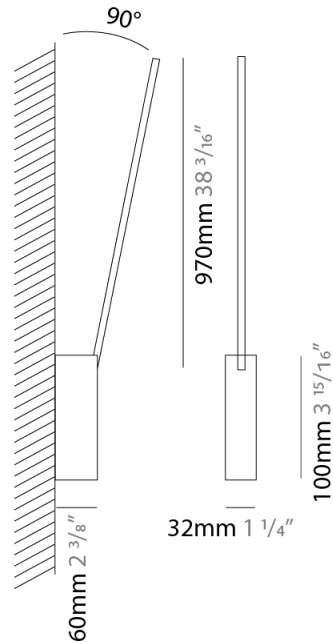
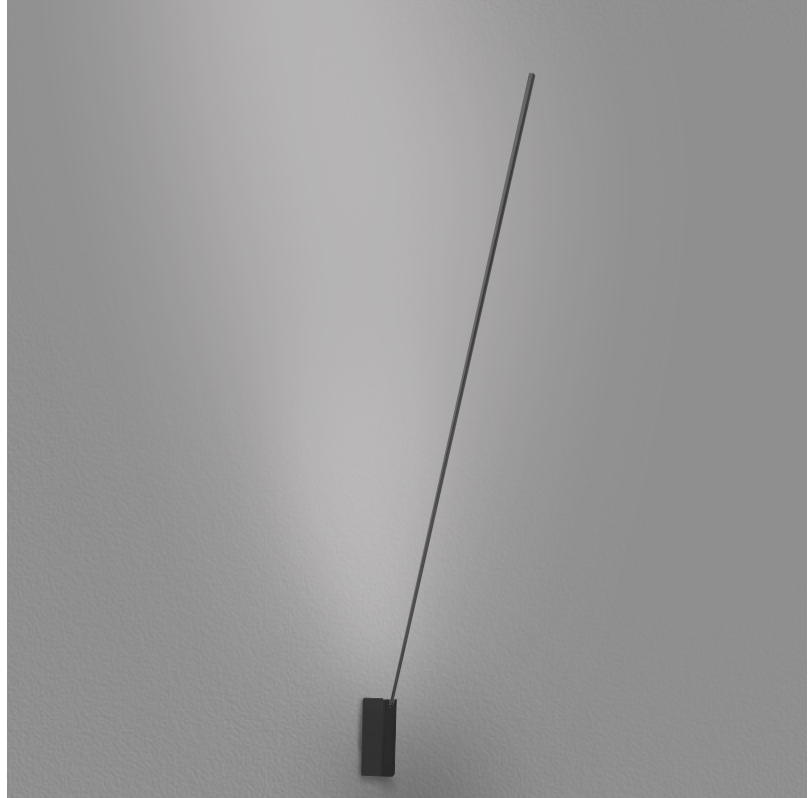

## SPILLO 1 ROD SURFACE

D42037-

PROJECT

TYPE

SPECIFIER

QUANTITY

DATE



D

## SPILLO 2 ROD SURFACE

**D42046-** -

base number                          
 Color            Temperature    Finish            Options

PROJECT \_\_\_\_\_  
 TYPE \_\_\_\_\_  
 SPECIFIER \_\_\_\_\_  
 QUANTITY \_\_\_\_\_  
 DATE \_\_\_\_\_

- To build a product code in our configurator select the specify button on the base model # product page
- To build a manual product code on this datasheet choose from the options listed below in blue font and add the suffix to the base model #

**GENERAL**

Series: Spillo  
 Subseries: Spillo 2 Rod  
 Brand: Icone  
 Division: Design  
 Mounting Type: Surface  
 Mounting Location: Wall  
 Subcategory: Ambient

**PHYSICAL**

Shape: Rectangle  
 Width (mm): 32  
 Width (in): 1 1/4  
 Height (mm): 1090  
 Height (in): 42 15/16  
 Extension (mm): 660  
 Extension (in): 26  
 Light Distribution: Direct / Indirect  
 Fixture Finish: WHI / WHC / BLK / BGD  
 Fixture Material: Brass

**ELECTRICAL**

Lamp Type: LED  
 Total Output Wattage (W): 11.88  
 Dimming: Non-Dimmable  
 Driver Included: Yes  
 Driver Location: Integrated  
 Driver Type: Constant Voltage - 120 / 277Vac  
 Driver Class: Class 2  
 Input Voltage (V): 120 - 277  
 Output Voltage (V): 12  
 Upon Request: (Not included - see components) Remote: 0-10Vdc dimming

**LED**

Color Temperature (°K): 2700 / 3000  
 Nominal Lumen (lm): 990  
 CRI: >90 CRI  
 Lamp Life (hrs): 50000

**OPTICAL**

Adjustability: Tilt 90°

**RATINGS AND CERTIFICATIONS**

Certified By: Certified for North American Standards  
 IP rating: IP20

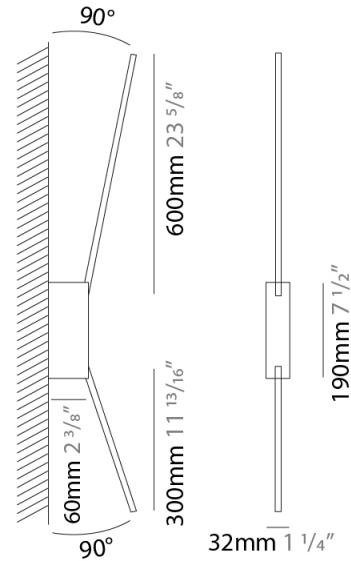
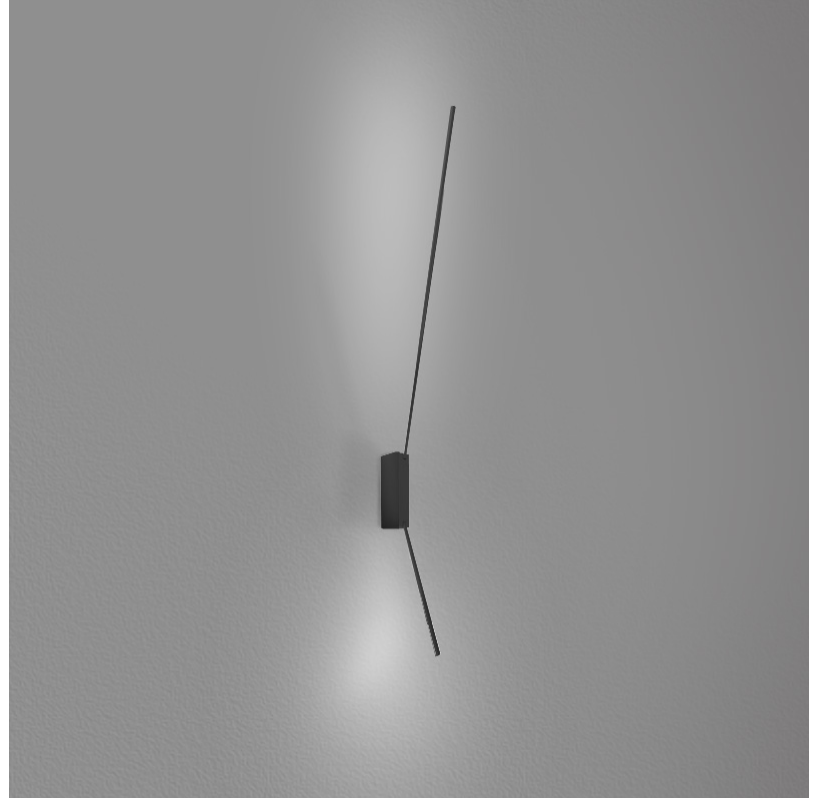

## SPILLO 2 ROD SURFACE

D42046-

PROJECT \_\_\_\_\_

TYPE \_\_\_\_\_

SPECIFIER \_\_\_\_\_

QUANTITY \_\_\_\_\_

DATE \_\_\_\_\_



D

## SPILLO 2 ROD SURFACE

**D42047-** -

base number                              
 Color            Finish  
 Temperature    Options

PROJECT
TYPE
SPECIFIER
QUANTITY
DATE

- To build a product code in our configurator select the specify button on the base model # product page
- To build a manual product code on this datasheet choose from the options listed below in blue font and add the suffix to the base model #

**GENERAL**

Series: Spillo  
 Subseries: Spillo 2 Rod  
 Brand: Icone  
 Division: Design  
 Mounting Type: Surface  
 Mounting Location: Wall  
 Subcategory: Ambient

**PHYSICAL**

Shape: Rectangle  
 Width (mm): 32  
 Width (in): 1 1/4  
 Height (mm): 1390  
 Height (in): 54 3/4  
 Extension (mm): 860  
 Extension (in): 33 7/8  
 Light Distribution: Direct / Indirect  
 Fixture Finish: WHI / WHC / BLK / BGD  
 Fixture Material: Brass

**ELECTRICAL**

Lamp Type: LED  
 Total Output Wattage (W): 15.36  
 Dimming: 0-10V Dimming  
 Driver Included: Yes  
 Driver Location: Integrated  
 Driver Type: Constant Current - 120Vac - non-dimming  
 Driver Class: Class 2  
 Input Voltage (V): 120 - 277  
 Output Voltage (V): 12  
 Upon Request: (Not included - see components) Remote: 0-10Vdc dimming / 277Vac

**LED**

Color Temperature (°K): 2700 / 3000  
 Nominal Lumen (lm): 1320  
 CRI: >90 CRI  
 Lamp Life (hrs): 50000

**OPTICAL**

Adjustability: Tilt 90°

**RATINGS AND CERTIFICATIONS**

Certified By: Certified for North American Standards  
 IP rating: IP20

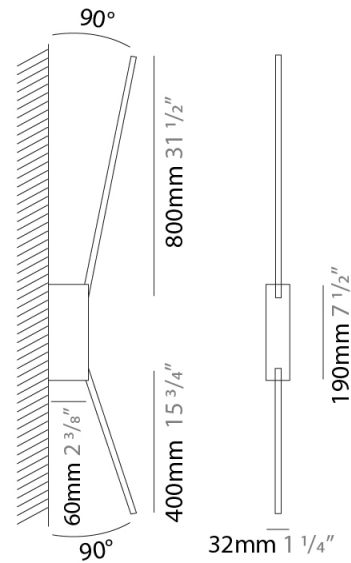
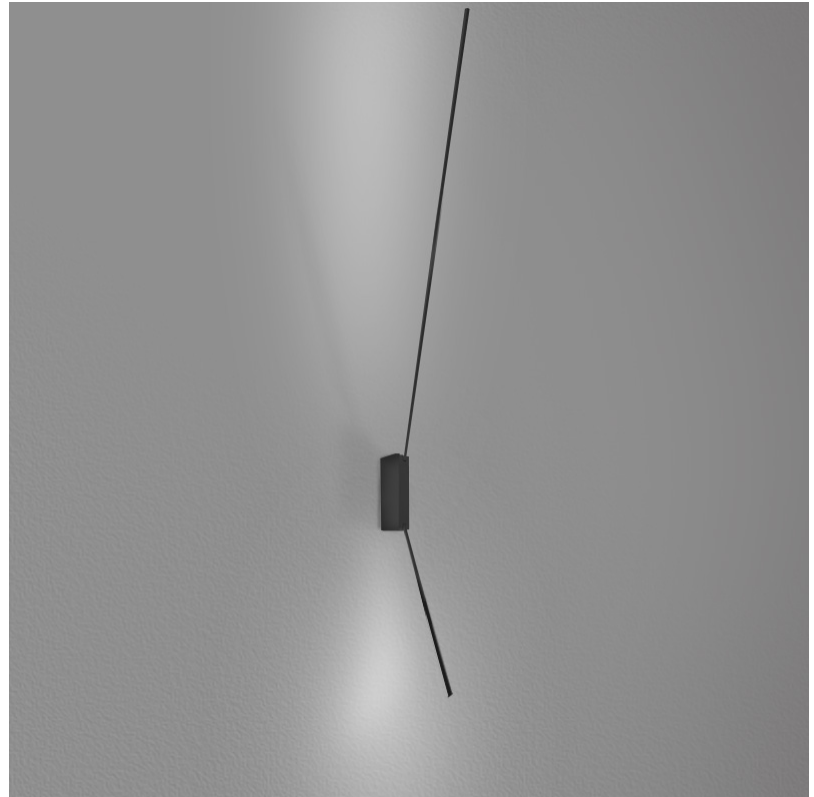

## SPILLO 2 ROD SURFACE

D42047-

PROJECT \_\_\_\_\_

TYPE \_\_\_\_\_

SPECIFIER \_\_\_\_\_

QUANTITY \_\_\_\_\_

DATE \_\_\_\_\_

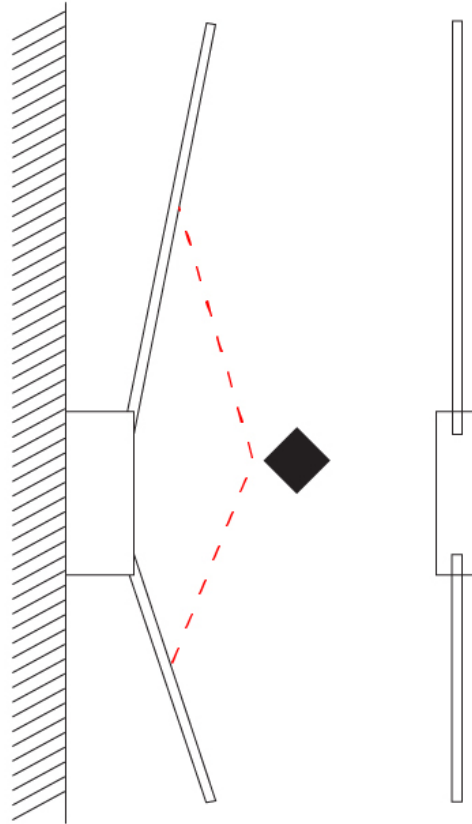



PROJECT	_____
TYPE	_____
SPECIFIER	_____
QUANTITY	_____
DATE	_____

## SPILLO 6 ROD SUSPENSION

**D42053-** \_\_\_\_\_ - \_\_\_\_\_  
 base number    Color    Finish  
                          Temperature    Options

- To build a product code in our configurator select the specify button on the base model # product page
- To build a manual product code on this datasheet choose from the options listed below in blue font and add the suffix to the base model #

### GENERAL

Series: Spillo  
 Subseries: Spillo 6 Rod  
 Brand: Icone  
 Division: Design  
 Mounting Type: Suspension  
 Mounting Location: Ceiling  
 Subcategory: Ambient

### PHYSICAL

Shape: Abstract  
 Height (mm): 1500  
 Height (in): 59 1/16  
 Light Distribution: Direct / Indirect  
 Fixture Finish: WHI / CHR / BGD  
 Fixture Material: Brass

### ELECTRICAL

Lamp Type: LED  
 Total Output Wattage (W): 47  
 Dimming: 0-10V Dimming  
 Driver Included: Yes  
 Driver Location: Integrated  
 Driver Type: Constant Current - Universal  
 Input Voltage (V): 120 - 277  
 Output Voltage (V): 12  
 Upon Request: (Included) Integral: Non-dimming / 277Vac / (Not included - see components) Remote: 0-10Vdc dimming

### LED

Color Temperature (°K): 2700 / 3000  
 Nominal Lumen (lm): 3960  
 CRI: >90 CRI  
 Lamp Life (hrs): 50000

### OPTICAL

### RATINGS AND CERTIFICATIONS

Certified By: Certified for North American Standards  
 IP rating: IP20

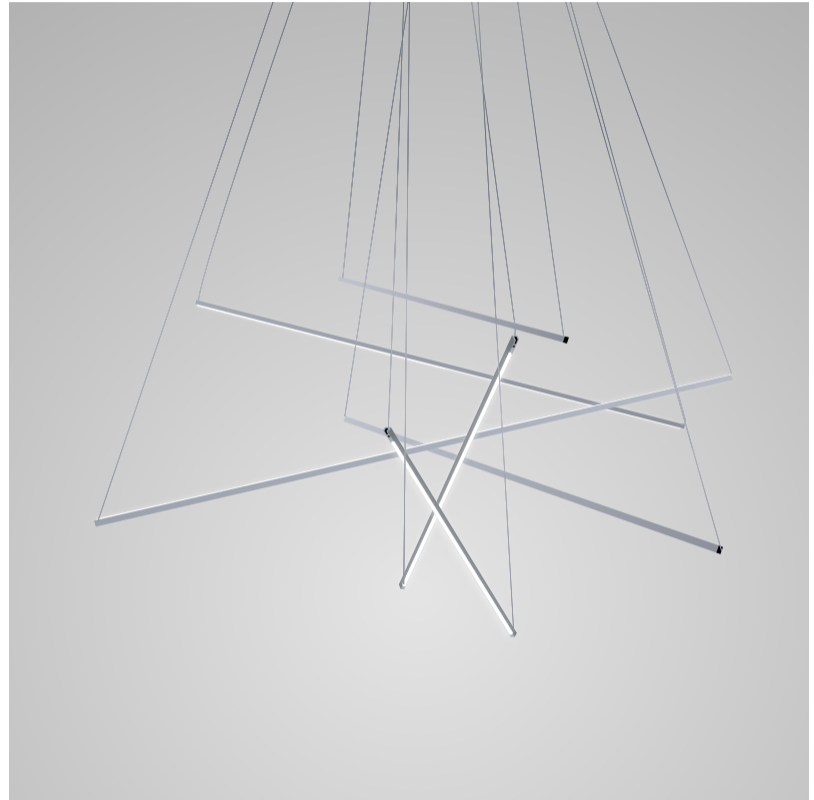

300mm 11 13/16"

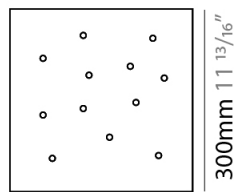

300mm 11 13/16"

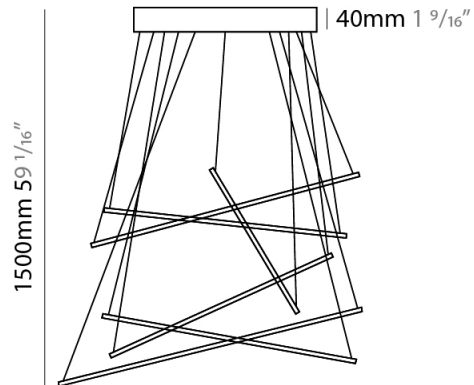

## SPILLO 6 ROD SUSPENSION

D42053-

PROJECT

TYPE

SPECIFIER

QUANTITY

DATE

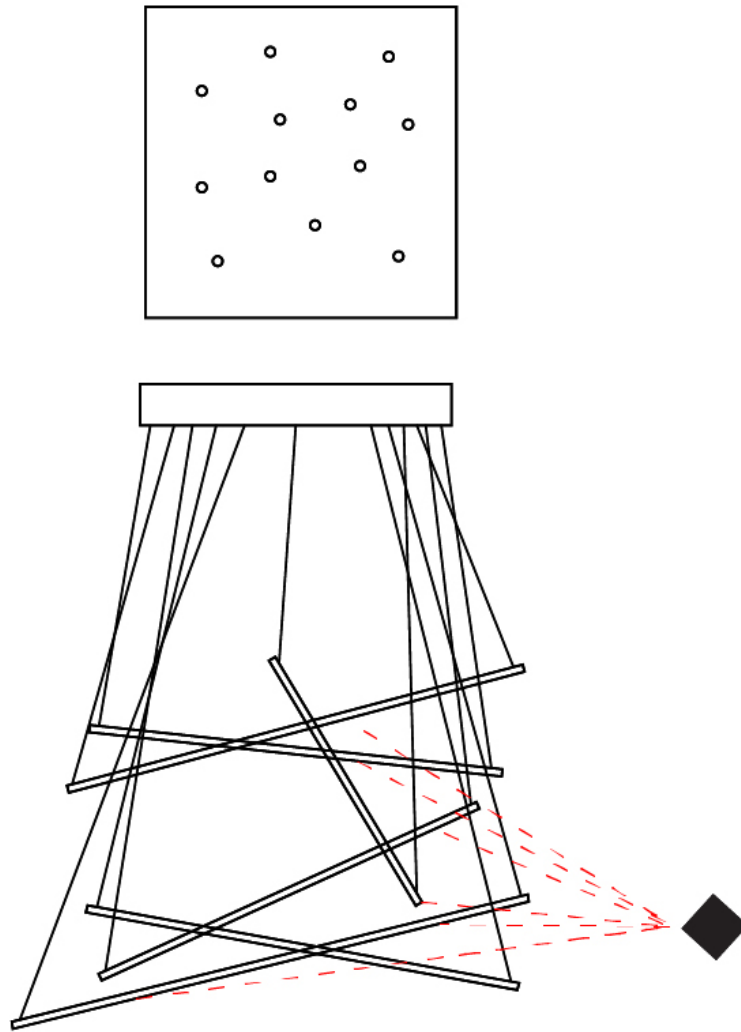

D

## SPILLO 2 ROD SURFACE

**D42055-** -

base number                          
 Color            Temperature    Finish            Options

PROJECT
TYPE
SPECIFIER
QUANTITY
DATE

- To build a product code in our configurator select the specify button on the base model # product page
- To build a manual product code on this datasheet choose from the options listed below in blue font and add the suffix to the base model #

**GENERAL**

Series: Spillo  
 Subseries: Spillo 2 Rod  
 Brand: Icone  
 Division: Design  
 Mounting Type: Surface  
 Mounting Location: Wall  
 Subcategory: Ambient

**PHYSICAL**

Shape: Rectangle  
 Width (mm): 32  
 Width (in): 1 1/4  
 Height (mm): 720  
 Height (in): 28 3/8  
 Extension (mm): 460  
 Extension (in): 18 1/8  
 Light Distribution: Direct / Indirect  
 Fixture Finish: WHI / WHC / BLK / BGD  
 Fixture Material: Brass

**ELECTRICAL**

Lamp Type: LED  
 Total Output Wattage (W): 7.44  
 Dimming: 0-10V Dimming  
 Driver Included: Yes  
 Driver Location: Integrated  
 Driver Type: Constant Voltage - 120Vac  
 Driver Class: Class 2  
 Input Voltage (V): 120 - 277  
 Output Voltage (V): 12  
 Upon Request: (Not included - see components) Remote: 0-10Vdc dimming / Non-dimming 120/277Vac

**LED**

Color Temperature (°K): 2700 / 3000  
 Nominal Lumen (lm): 660  
 CRI: >90 CRI

**OPTICAL**

Adjustability: Tilt 90°

**RATINGS AND CERTIFICATIONS**

Certified By: Certified for North American Standards  
 IP rating: IP20

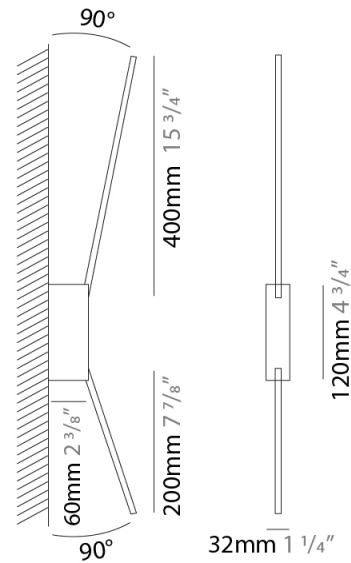
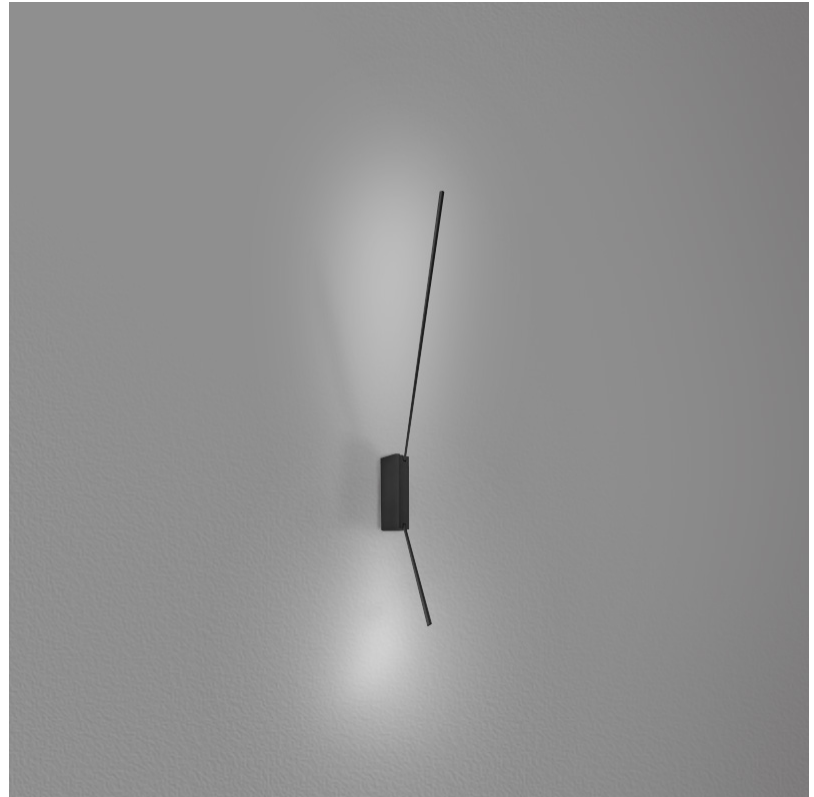

## SPILO 2 ROD SURFACE

D42055-

PROJECT

TYPE

SPECIFIER

QUANTITY

DATE

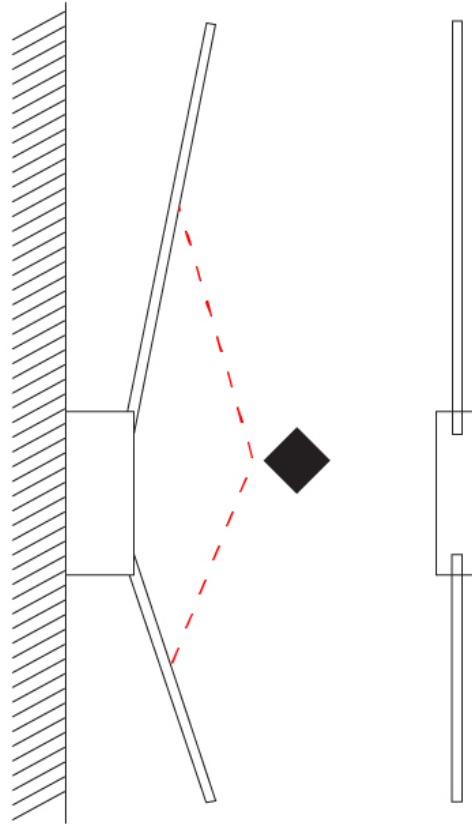

PROJECT	_____
TYPE	_____
SPECIFIER	_____
QUANTITY	_____
DATE	_____

## SPILLO 5 ROD SURFACE

**D42068-** \_\_\_\_\_ - \_\_\_\_\_

base number    Color    Finish  
 Temperature    Options

- To build a product code in our configurator select the specify button on the base model # product page
- To build a manual product code on this datasheet choose from the options listed below in blue font and add the suffix to the base model #

### GENERAL

Series: Spillo  
 Subseries: Spillo 5 Rod  
 Brand: Icone  
 Division: Design  
 Mounting Type: Surface  
 Mounting Location: Ceiling  
 Subcategory: Ambient

### PHYSICAL

Shape: Abstract  
 Height (mm): 1030  
 Height (in): 40 <sup>9</sup>/<sub>16</sub>  
 Light Distribution: Direct / Indirect  
 Fixture Finish: WHI / BLK / CHR / BGD  
 Fixture Material: Brass

### ELECTRICAL

Lamp Type: LED  
 Total Output Wattage (W): 45.72  
 Dimming: 0-10V Dimming  
 Driver Included: Yes  
 Driver Location: Integrated  
 Driver Type: Constant Voltage - 120-277Vac Non-dimming  
 Driver Class: Class 2  
 Input Voltage (V): 120 - 277  
 Output Voltage (V): 12  
 Upon Request: (Not included, see components) Remote: 0-10Vdc dimming / (Included) Integral: Non-dimming / 277Vac

### LED

Color Temperature (°K): 2700 / 3000  
 Nominal Lumen (lm): 3850  
 CRI: >90 CRI  
 Lamp Life (hrs): 50000

### OPTICAL

### RATINGS AND CERTIFICATIONS

Certified By: Certified for North American Standards  
 IP rating: IP20

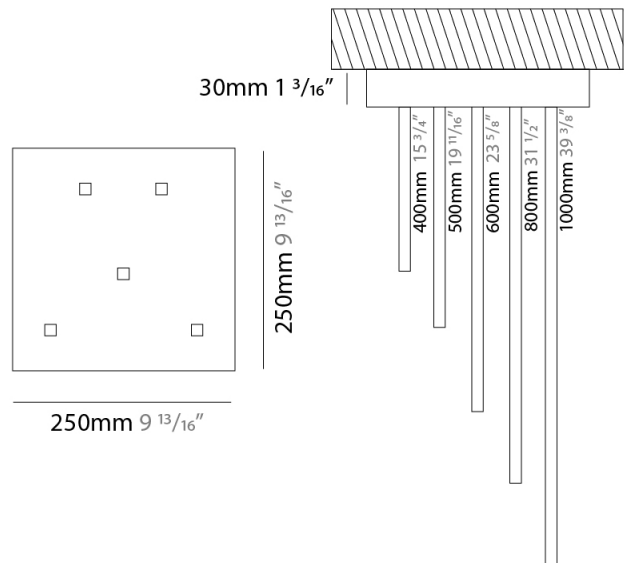

## SPILLO 5 ROD SURFACE

D42068-

PROJECT
TYPE
SPECIFIER
QUANTITY
DATE



D

## SPILLO COLOR FINISH CHART

PROJECT

TYPE

SPECIFIER

QUANTITY

DATE

### Fixture Finish

White - WHI

White/Chrome - WHC

Black - BLK

Brushed Gold - BGD

Chrome - CHR

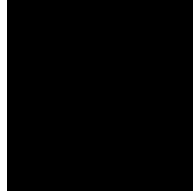





































































**Digital:** Not all screens are calibrated the same, and therefore, colors will appear differently between screens.

**Physical:** When texture is involved, there will be variations in color, character and tone within a product series and between product families.





### LEGEND

	floor-mounted		pivotal		special LED (upon request) RGB, RGBW, tunable, gold+, meat+, art+, fashion+
	wall and ceiling: recessed and surface mounted		rotating		warm dim / natural dimming LED
	ceiling-mounted and wall-mounted		illuminate tilted		rechargeable battery powered
	wall-mounted		color of suspension cable		fixture with natural vivid LED (upon request)
	omni-directional light distribution		length of suspension cable		color rendering index
	direct light distribution		reflector degree selection		color temperature
	direct/indirect light distribution		super spot		lumen (luminous flux)
	indirect light distribution		lens		efficacy (lumens per watt)
	asymmetric light distribution		lens pack		Unified Glare Rating (UGR) range from 5-40
	aura light distribution		shine ring		marine grade (AISI 316 stainless steel)
	round wall or ceiling cut-out		integrated shine ring with diffuser		walk on
	square wall or ceiling cut-out		free individual colors 01-29		drive on
	the supplied jig specifies the cutout dimensions		individual colors: 00 (free of charge), 01-25 (extra charge)		Dark Sky Compliance
	minimum distance (meters) lamp - object		luminaire part to be colored (F1)		Americans with Disabilities Act (less than 4" off the wall located between 27"-84" from floor)
	recessed depth		luminaire part to be colored (F2)		lamp protected against explosion
	ceiling thickness in mm		luminaire part to be colored (F3)		blown glass using traditional methods by master glass blower
	ceiling thickness selection		luminaire part to be colored (F4)		acoustic material
	dimmable DP (phase), DV (0-10V), DD (dali), DS (step-dim)		luminaire part to be colored (F5)		protection class I, protection insulation
	included or excluded LED driver/transformer/control gear		color of 3-circuit adaptor		protection class II, protection insulation
	separately switchable		indirect diffuser		ETL Certified to UL and CSA Standards
	sensor		direct diffuser		UL Certified to UL and CSA Standards
	remote control		ball-proof (upon request)		CSA Certified to UL and CSA Standards
	available upon request		accessory		Certified for North American Standards

### IP RATING

	protected against ingress of solid bodies greater than 12.5mm (finger)
	protected against ingress of solid bodies greater than 2.5mm protected against sprays of water up to 60 degrees from the vertical (rain)
	protected against ingress of solid bodies greater than 1mm (wire) no protection against the ingress of moisture
	protected against ingress of solid bodies greater than 1mm (wire) protected against sprays of water up to 60 degrees from the vertical (rain)
	protected against ingress of solid bodies greater than 1mm (wire) protected against water splashed from all directions
	protected against limited ingress of dust (wet rooms/covered outdoor areas) protected against water splashed from all directions
	protected against ingress of dust protected against jets of water
	protected against ingress of dust protected against powerful jets of water or heavy seas
	protected against ingress of dust protected against immersion of water between 15cm - 1m for 30 minutes
	protected against ingress of dust protected against immersion of water under pressure for long periods

### IK RATING

	protected against 0.14 joules impact (equivalent to 0.25kg mass dropped from 56mm above the surface)
	protected against 0.2 joules impact (equivalent to 0.25kg mass dropped from 80mm above the surface)
	protected against 0.35 joules impact (equivalent to 0.25kg mass dropped from 140mm above the surface)
	protected against 0.5 joules impact (equivalent to 0.25kg mass dropped from 200mm above the surface)
	protected against 0.7 joules impact (equivalent to 0.25kg mass dropped from 280mm above the surface)
	protected against 1 joules impact (equivalent to 0.25kg mass dropped from 400mm above the surface)
	protected against 2 joules impact (equivalent to 0.5kg mass dropped from 400mm above the surface)
	protected against 5 joules impact (equivalent to 1.7kg mass dropped from 300mm above the surface)
	protected against 10 joules impact (equivalent to 5.0kg mass dropped from 200mm above the surface)
	protected against 20 joules impact (equivalent to 5.0kg mass dropped from 400mm above the surface)